

FPGA Configuration

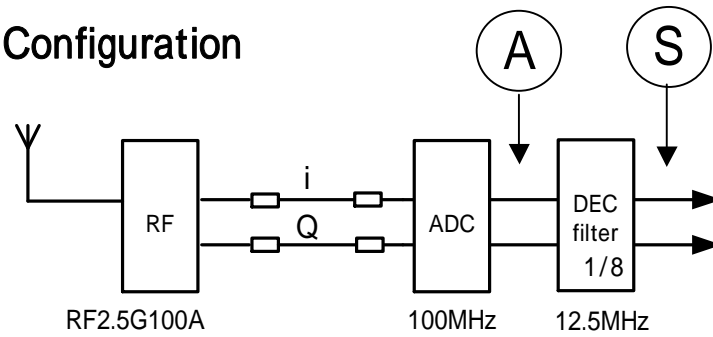

A ADC出力観測

Constellation

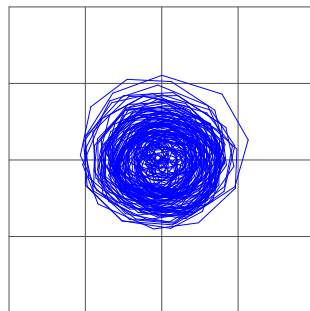

10MHz (15.0391 - 4.98047 = 10.05864)

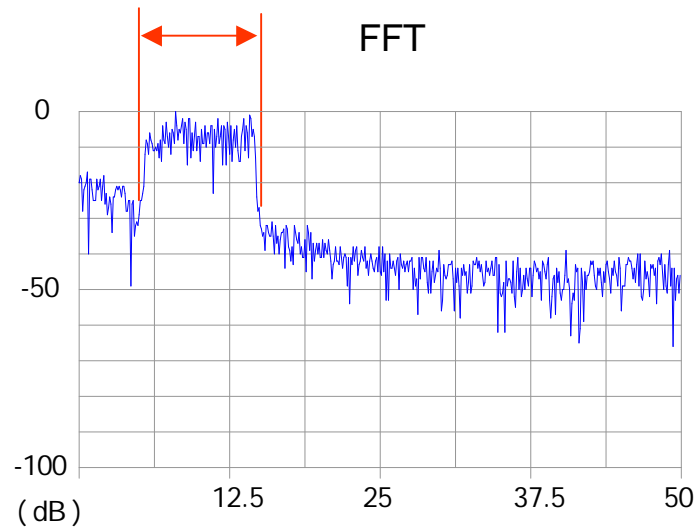

受信帯域: F3

A ADC出力観測

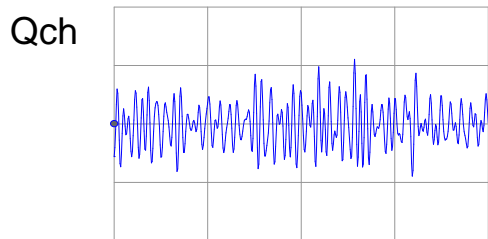
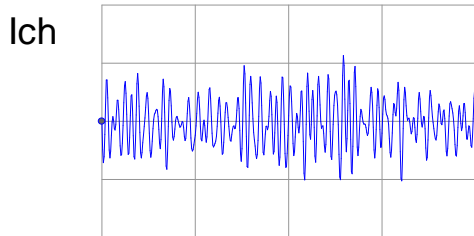

FFT

Ich

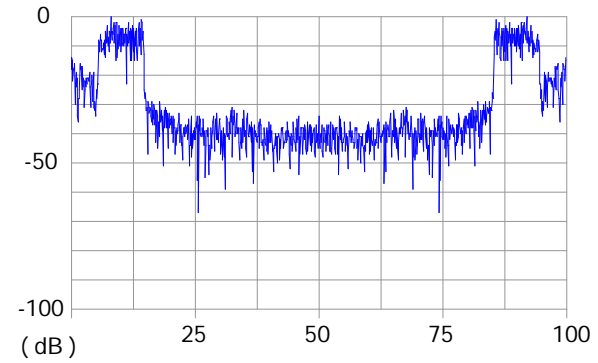

Qch

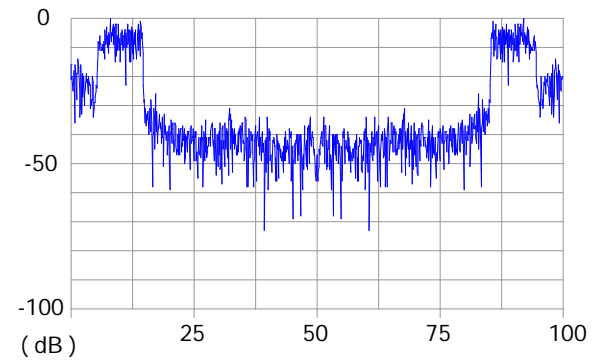

Complex

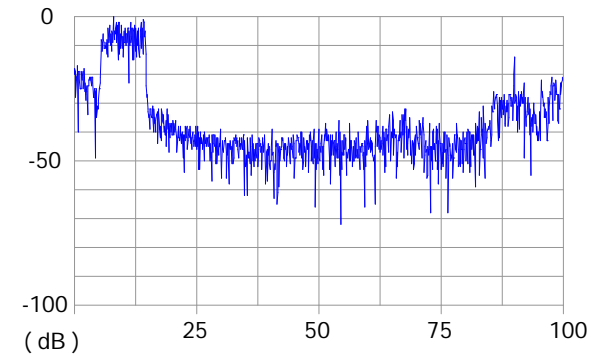

S

シンボル出力観測

Constellation

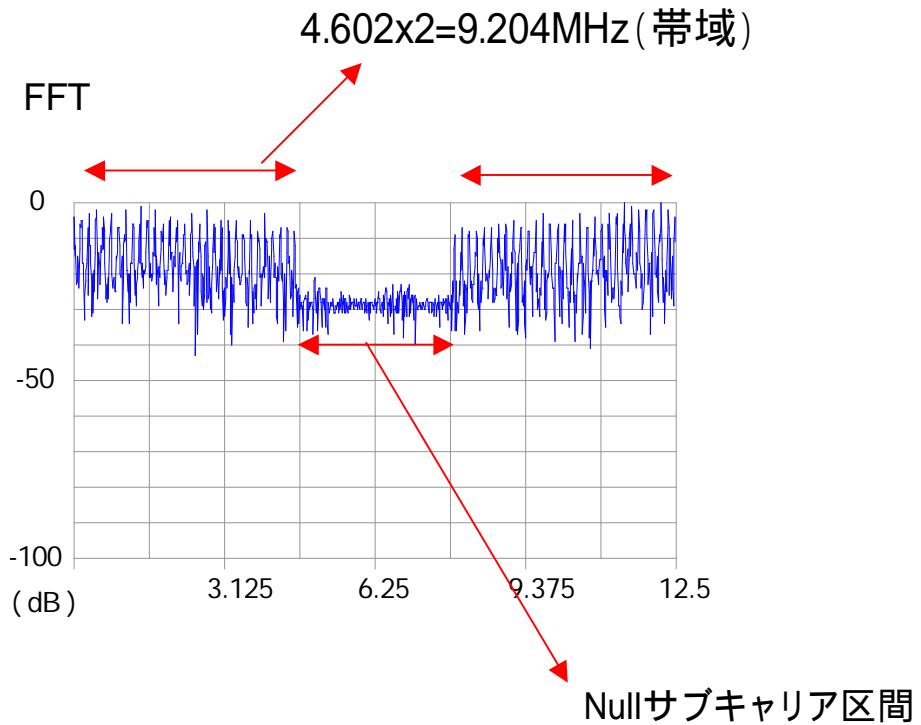
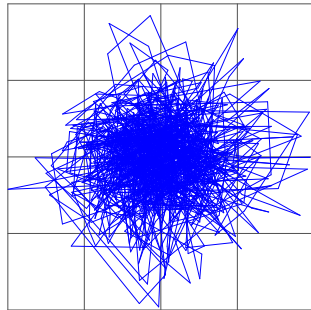
WiMax 規格 $11.2 * (1 - 184 / 1024) = 9.1875\text{M}$

FPGA implementation

File Name: XP053A_SFTqpsk.rbt
XF053A_SFTqpsk.rbt
RF053A_SFTqpsk.rbt

Signals

Port	Signals
3	ADC出力
4	検波出力

Control Registers

REG No	REG名称	Byte	機能
REG9	RF control	1byte	0:受信